

DEMO MANUAL

J- Series IVA 80-3

IVA 80-3



IVA 80-3
80cm 3 burner hob
Article : 538.02.866

Salient Features



- **Supernova wok burner** is unique and highly efficient. The targeted flame delivers heat with high effectiveness and accuracy exactly where it is needed – in the middle of the wok bottom. This leads to cooking effects that are otherwise only possible with special Indian lotus wok burners. The flames can take the shape of the pot or the pans places on it.
- **Burners:**
 - 1 Supernova Triple Flame Wok Burner : with adjustable inner ring flames (0.3kW – 5kW)
 - 1 Supernova Mini Triple Flame Burner : Ideal for making Indian Chapati (3kW)
 - 1 Dual Flame Burner : meant for slow cooking and light sautéing (2kW)



Installation Diagram

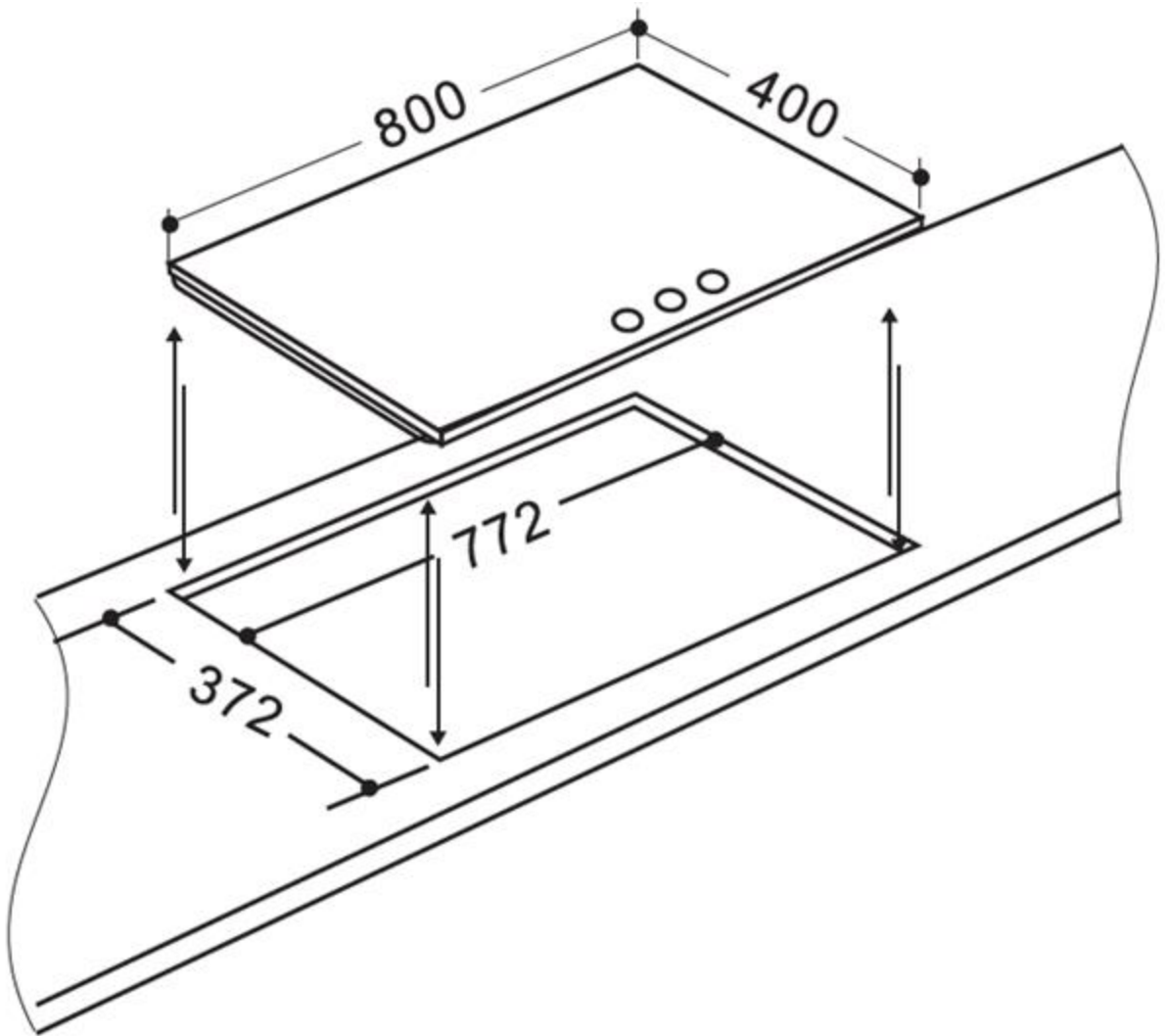

Demo Points

- **Gas Pressure : 2.8kPa**
 - This is a low pressure appliances suitable for LPG gas supply.
 - For Natural Gas, it is recommended to do necessary changes in the jets and nozzles to make it compatible for a Natural Gas source.
- **Flame Failure Safety Device:**
 - All the burners are equipped with FFSD which will avert major accidents that occurs due to leakage of gas when flame goes off accidentally.
 - The device senses the heat to allow and clear the passage of the gas that flows in to the burner
 - Hence, it takes 5 - 10 seconds while igniting the burner.
- **Electric Ignition**
 - The knob should be turned left to the ON position and should be held in this position for 5-10 seconds. This allows the flame to heat the FFSD, that will finally open the passage of the gas
- **Special Metal Knob**
 - The knob is a specially designed metal knob with soft touch finish. Care should be taken while cleaning of the knob. It may attract scratch in case of contact with rough and sharp surfaces
 - Refrain placing hot pan / pot while cooking on the knobs. It may heat the knob. Nominal heating of knob is normal as it is a metal knob and has a long service life



1- The burner lid needs to be placed properly on the burner cups. Improper placements will result in deformation of burners.

2- The edges of the glass hobs should not be strained or hitted. This might result in breakage. The toughened glasses can take up strain anywhere except on the edges

Appliances Care

- Important parts of the appliances, like, Glass surface, FFSD, Ignition pin, burners, drip tray & pan supports needs to be cleaned everyday for smooth performance.
- Refrain from using harsh detergents & scrubbing agents to clean these parts. This might scratch and cause damage to the product.
- Use of soft cloth or sponge with mild liquid cleaning agent should be used always. Use of rough cloth or scrubber may result in scratched on the drip tray and burner
- **Placement of burner lid:** The brass burner lid should be placed properly on the burner cups till it fits in completely. Improper placement of the burner cap will result in burner deformation as the flame distribution will be uneven.
- **Flame color:** in case of yellow flames, please check the below:
 - Supply of Gas: in case of impurity in gas source, the flame output is yellow
 - Ventilation : Proper ventilation should be provided to avoid incomplete combustion that causes Yellow flames. These top air burner models takes in the oxygen from outside to give desirable flame output
 - Carbon formation : Clean the burners regularly to avoid carbon formation. Usually the food leftovers on the hob tend to burn and form a layer of carbon on the holes of the burner lid. This also one of the causes of Yellow flame.
- **Normal wear & tear:**
 - Gradual fading of the coating on the burner caps
 - Fading of drip tray in due course of time
 - Minor scratches on glass surface

HAFELE

**Mumbai Design Centre:**

#2 Filix Building, Opp. Asian Paints,
L.B.S. Marg, Bhandup (west),
Mumbai - 400 078.
Tel.: 022 2596 9660/ 2594 7305/ 2596 9787.

Timings: Monday to Saturday: 10am - 7pm
Sunday: 11am - 6pm

Mumbai Corporate Office:

Office No. 3, Building "A", BETA, I Think
Techno Campus, Off J.V.L.R.,
Opp. Kanjurmarg East, Mumbai - 400 042.
Tel.: 022 6142 6100 • Fax: 022 6702 0531.

New Delhi Design Centre:

D-89, 1st Floor, Okhla Phase-I,
New Delhi - 110 020.
Tel.: 011-66574999 • Fax: 011-41605482.

Bangalore Design Centre:

No. 2/1, "Shiv Manor",
Langford Road, Shanthi Nagar,
Bangalore - 560 027.
Tel.: 080 4132 6116 • Fax: 080 4132 6226.

Hyderabad Design Centre:

Park Side, 8-2-348/3/4, Road No. 3,
Above Almond House, Banjara Hills,
Hyderabad - 500 034.
Tel.: 040 6666 8851 • Fax: 040 6666 8852.

Kolkata Design Centre:

PS PACE, Premises No. 1/1A, Mahendra Roy
Lane, Topsia, Kolkata - 700 046.
Tel.: 033 40086814/033 40089268.
Fax: 033 24988020.

Chennai Design Centre:

New No. 20, (Old No. 63), 1st Main Road,
Besant Nagar, Chennai - 600 090.
Tel.: 044 - 4215 1542 • Fax: 044 2446 0922.

Pune Office:

Office No. 12, Vastushree Complex,
Survey No.587, Near Hyde Park,
Gultekdi, Market Yard, Pune - 411 037.
Tel.: 020 2426 6264 • Fax: 020 2426 6274.

For Enquiries**SMS "HAFELE" to 56070****Sri Lanka Design Centre:**

448, Galle Road,
Rawathawatta, Moratuwa
Tel.: +94 112 644 600.

Bangladesh:

Tilottama Design Studio
Road : 138, House : 8/A,
Gulshan 1, Dhaka - 1212
Tel.: 880-2-9886526
Mob: 8801-672434394.

Nepal

Monika Home Decor
Kathmandu Plaza, Kamaldhi,
Kathmandu, Nepal
Tel.: +977 9851 030 556/
+ 977 9818496082.

Bhutan

S C & K Marketing and Sales
First Floor, Hotel 89 Building
Chorten Lam, Thimphu, BHUTAN
Tel.: 975 2 333419 / 77114228 /
17600663.



<http://facebook.com/hafeleindia>



<http://www.twitter.com/hafeleindia>

